



OUR GLOBAL  
COMPETENCE  
CENTRES

 APOLLO DISPLAY  
TECHNOLOGIES



 DISTEC



 DISPLAY  
TECHNOLOGY



# Datasheet

## Ampire

**AM-19201080D1TZQW-A1H**

15.6" TFT

AM-10-009



晶采光電科技股份有限公司  
AMPIRE CO., LTD.

## SPECIFICATIONS FOR LCD MODULE

<b>CUSTOMER</b>	
<b>CUSTOMER PART NO.</b>	
<b>AMPIRE PART NO.</b>	<b>AM-19201080D1TZQW-A1H</b>
<b>APPROVED BY</b>	
<b>DATE</b>	

Approved For Specifications

Approved For Specifications & Sample

**AMPIRE CO., LTD.**

**4F., No.116, Sec. 1, Xintai 5th Rd., Xizhi Dist., New Taipei  
City221, Taiwan (R.O.C.)**

**新北市汐止區新台五路一段 116 號 4 樓(東方科學園區 A 棟)**

**TEL:886-2-26967269 , FAX:886-2-26967196 or 26967270**

APPROVED BY	CHECKED BY	ORGANIZED BY

## RECORD OF REVISION

Revision Date	Page	Contents	Editor
2019/08/12	--	New Release	Mantle
2019/08/22	22,23	Rename to 19201080D1TZQW-A1H	Mantle
2019/09/18	4	Operation Temperature & Note	Mantle
	17,18	Led current: 480mA to 440mA	
	19	Reliability test :Operation Temperature	

## 1.0 General Descriptions

### 1.1 Introduction

The LCM is a color active matrix TFT LCD module using amorphous silicon TFT's (Thin Film Transistors) as an active switching devices. This module has a 15.6 inch diagonally measured active area with FHD resolutions (1920 horizontal by 1080 vertical pixel array). Each pixel is divided into RED, GREEN, BLUE dots which are arranged in vertical Stripe and this module can display 16M colors(6bit+FRC). The TFT-LCD panel used for this module is a low reflection and higher color type.

### 1.2 Features

- 3.3 V Logic Power
- LVDS (2ch) Interface for 1920 RGB x 1080 resolution
- 16M Colors(6bit+FRC)
- On board LED Driving circuit
- Green Product (RoHS)

### 1.3 Product Summary

Items	Specifications	Unit
Screen Diagonal	15.6	Inch
Active Area	344.16 (H) ×193.59 (V)	mm
Pixel Format	1920 (H) x RGB x 1080 (V)	-
Pixel Pitch	0.17925 (H) X 0.17925 (V)	mm
Pixel Arrangement	R.G.B. Vertical Stripe	-
Display Mode	Normally Black	-
White Luminance	1000 (Typ)	cd /m2
Contrast Ratio	800 : 1 (Typ)	-
Input Voltage	3.3	V
Outline Dimensions	363.8x215.9Vx12.1	mm
Support Color	16M(6Bit+FRC)	-

## 2.0 Absolute Maximum Ratings

ITEM	SYMBOL	VALUES		UNIT	REMARK
		MIN	MAX		
Logic Signal Input Level	V <sub>in</sub>	-0.3	4.0	V	
Power Supply Voltage	V <sub>cc</sub>	-0.3	3.6	V	
Operation Temperature	T <sub>op</sub>	-30	75	°C	Note(1)
Storage Temperature	T <sub>st</sub>	-30	80	°C	

Note (1) Permanent damage may occur to the LCD module if you operate beyond this specification. [Please reduce the back-light current to a half by PWM at 70~75°C. To prevent the back-light material waving.](#)

Note (2) T<sub>a</sub> =25±2°C

### 3.0 ELECTRICAL SPECIFICATIONS

#### 3.1 LCD ELECTRONICS SPECIFICATION

Parameter	Symbol	Value			Unit	Note
		Min	Typ.	Max.		
Power Supply Voltage	Vcc	3.15	3.3	3.6	V	-
Ripple Voltage	VRP	-	-	150	mV	-
Rush Current	IRUSH	-	-	3	A	(2)
Power Supply Current	White	-	1.22	1.5	A	(3)a
	Black	-	0.51	0.7	A	(3)b
	Vertical Stripe	-	0.82	1	A	(3)c
Power Consumption	PLCD	-	4	5	Watt	(4)
LVDS differential input voltage	Vid	200		600	mV	(5)
LVDS common input voltage	Vic	1.0	1.2	1.4	V	(6)
LVDS terminating resistor	Rt		100		ohm	

Note(1) The ambient temperature is  $T_a = 25 \pm 2^\circ\text{C}$

Note(2) Measurement Conditions:

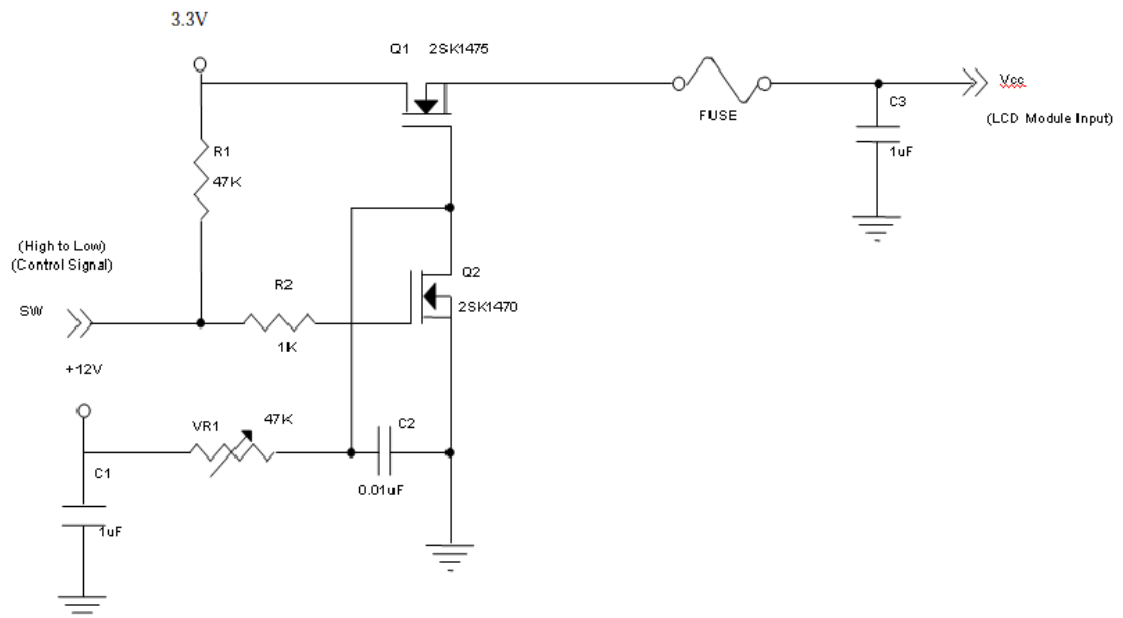

**Vcc rising time is 470μs**

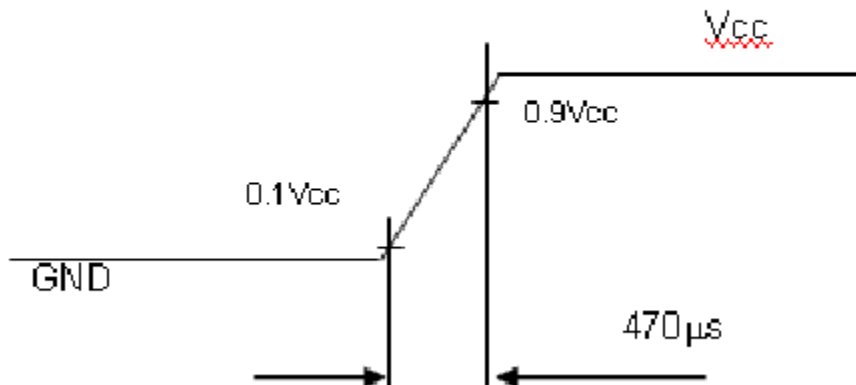

Note(3) The specified power supply current is under the conditions at  $V_{CC}=3V$ ,  $T_a=25\pm 2^{\circ}C$ ,  $F_r=60Hz$ , whereas a power dissipation check pattern below is displayed.

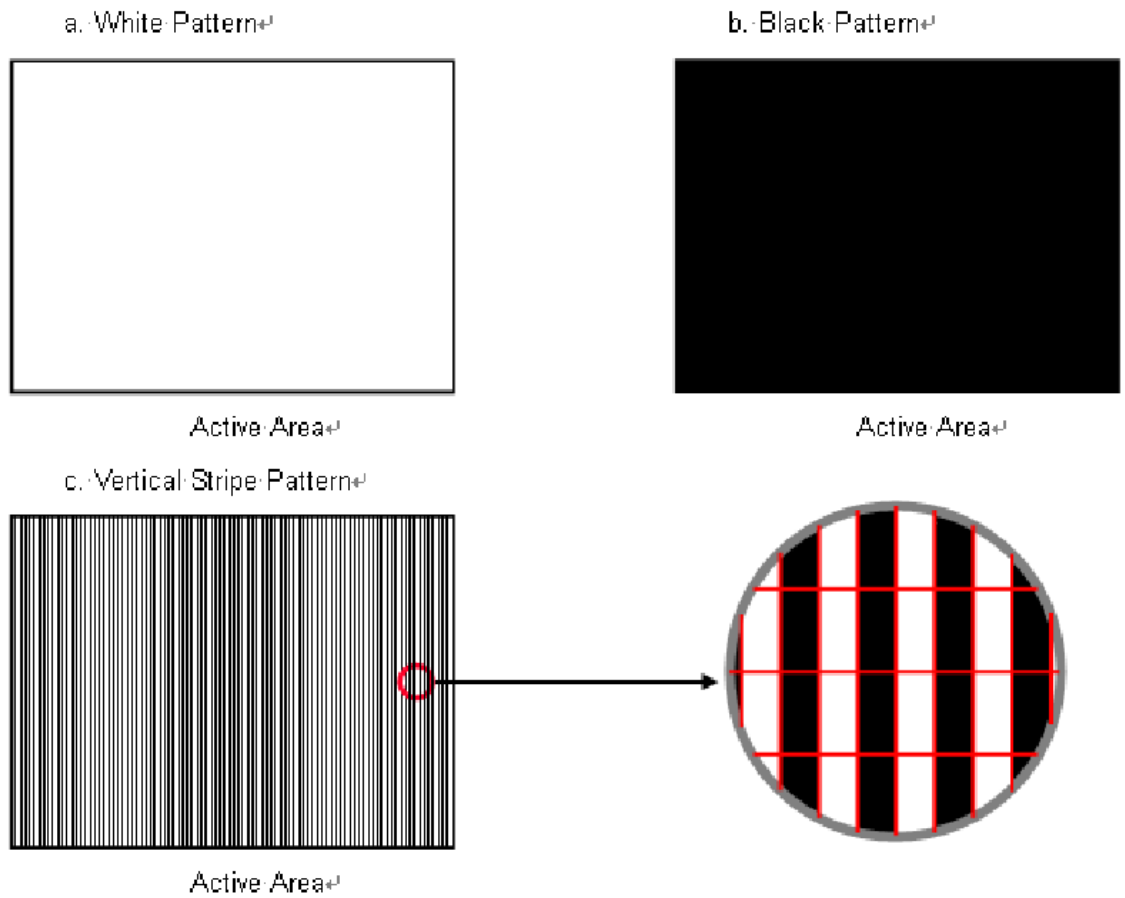

Note(4) The power consumption is specified at the pattern with the maximum current.

Note(5) VID waveform condition

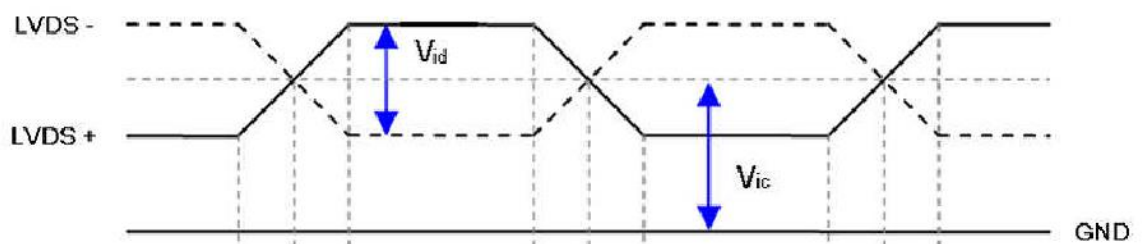



## 4. Interface Timings

### 4.1 DISPLAY TIMING SPECIFICATIONS

The input signal timing specifications are shown as the following table and timing diagram.

Signal	Item	Symbol	Min.	Typ.	Max.	Unit	Note
LVDS Clock	Frequency	Fc	60	70.93	75	MHz	-
	Period	Tc		14.1		ns	
	Input cycle to cycle jitter	T <sub>rd</sub>	-0.02*Tc		0.02*Tc	ns	(3)
	Input clock to data skew	TLVCCS	-0.02*Tc		0.02*Tc	ns	(4)
	Spread spectrum modulation range	Fclk <sub>in_mod</sub>	FC*98%		FC*102%	MHz	(5)
	Spread spectrum modulation frequency	F <sub>SSM</sub>			200	KHz	
Vertical Display Term	Frame Rate	Fr	50	60	60	Hz	Tv=Tvd+Tvb
	Total	Tv	1090	1110	1130	Th	-
	Active Display	Tvd	1080	1080	1080	Th	-
	Blank	Tvb	Tv-Tvd	30	Tv-Tvd	Th	-
Horizontal Display Term	Total	Th	1050	1065	1075	Tc	Th=Thd+Thb
	Active Display	Thd	960	960	960	Tc	-
	Blank	Thb	Th-Thd	105	Th-Thd	Tc	-

Note(1) Because this module is operated by DE only mode, Hsync and Vsync input signals are ignored.

Note(2) The  $T_v(T_{vd}+T_{vb})$  must be integer, otherwise this module would operate abnormally.

#### INPUT SIGNAL TIMING DIAGRAM

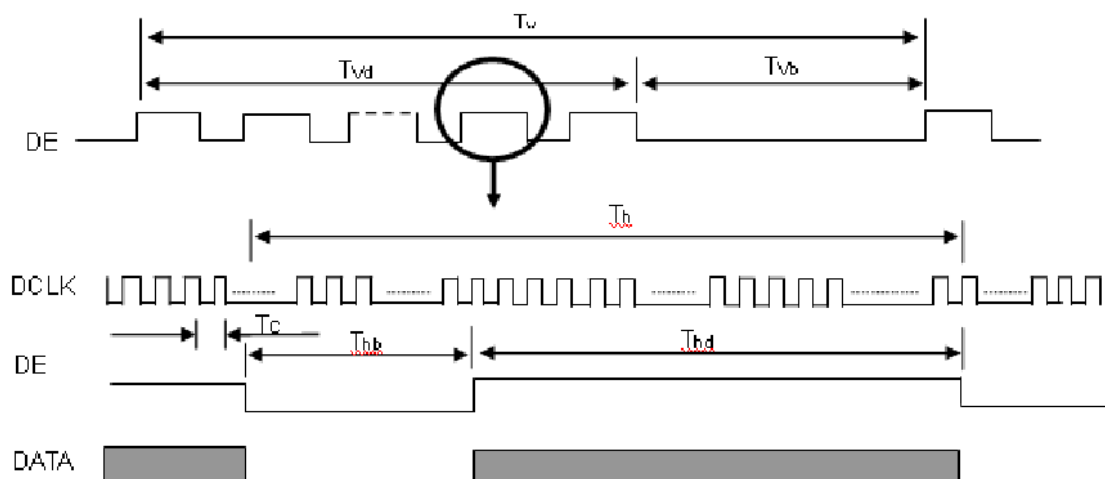

Note(3) The input clock cycle-to-cycle jitter is defined as below figures.  $Trcl = |T_1 - T_2|$

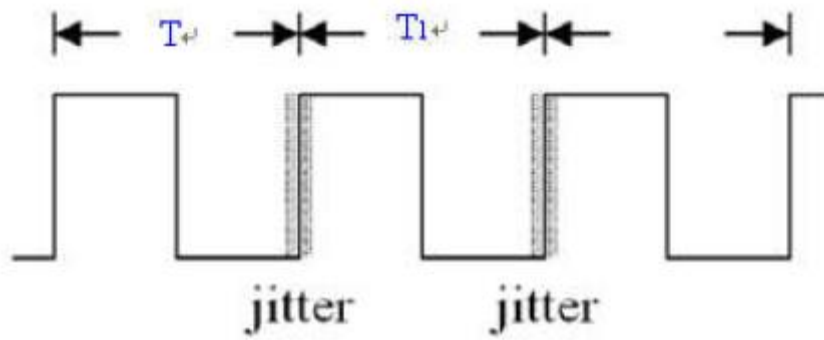

Note(4) Input Clock to data skew is defined as below figures.

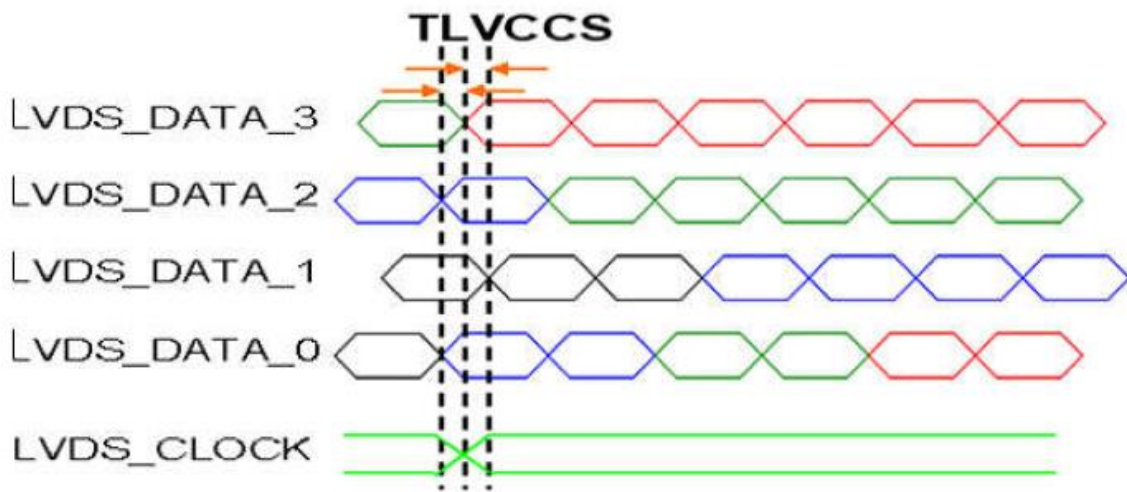

Note(5) The SSCG (Spread spectrum clock generator) is defined as below figures.

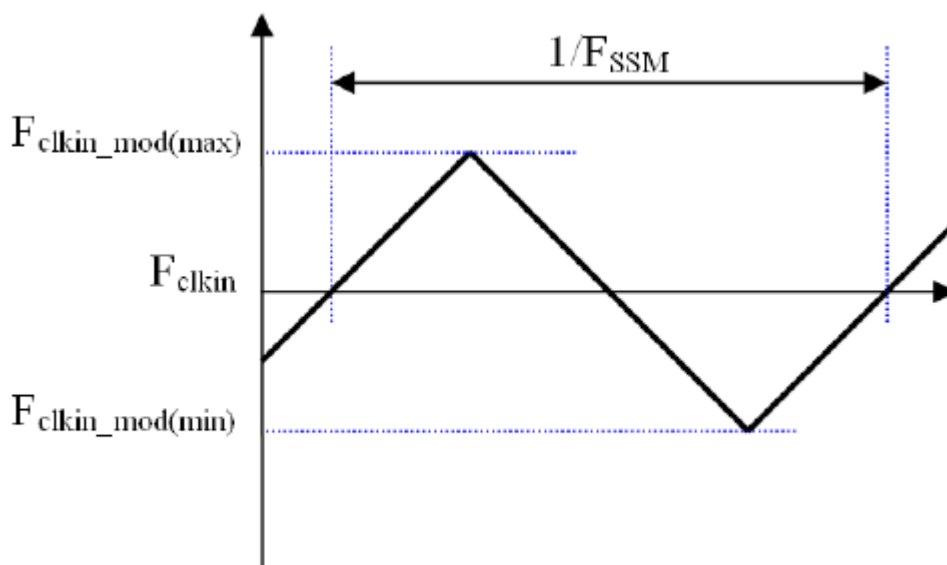

## 4.2 POWER ON/OFF SEQUENCE

The power swquence specifications are shown as the following table and diagram.

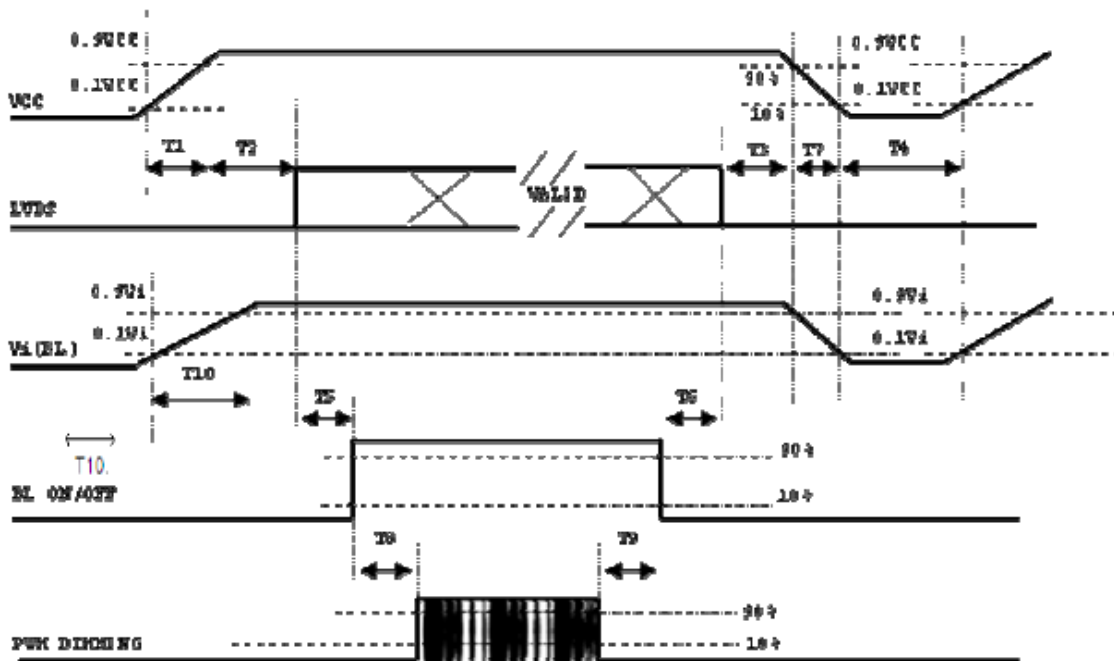

Timing Specifications:

Parameter	Value			Units
	Min	Typ	Max	
T1	0.5	-	10	ms
T2	0	-	50	ms
T3	0	-	50	ms
T4	500	-	-	ms
T5	450	-	-	ms
T6	200	-	-	ms
T7	10	-	100	ms
T8	10	-	-	ms
T9	10	-	-	ms
T10	20	-	50	ms

Note (1) The supply voltage of the external system for the module input should be the same as the definition of Vcc.

Note (2) When the backlight turns on before the LCD operation of the LCD turns off, the display may momentarily become abnormal screen.

- Note (3) In case of Vcc = off level, please keep the level of input signals on the low or keep a high impedance.
- Note (4) T4 should be measured after the module has been fully discharged between power off and on period.
- Note (5) Interface signal shall not be kept at high impedance when the power is on.
- Note (6) There might be slight electronic noise when LCD is turned off(even backlight unit is also off).To avoid this symptom, we suggest "Vcc falling timing" o follow"T7 spec".

## 4.3 LVDS INPUT SIGNAL SPECIFICATIONS

### 4.3.1 LVDS DATA MAPPING TABLE

LVDS Channel O0	LVDS output	D7	D6	D4	D3	D2	D1	D0
	Data order	OG0	OR5	OR4	OR3	OR2	OR1	OR0
LVDS Channel O1	LVDS output	D18	D15	D14	D13	D12	D9	D8
	Data order	OB1	OB0	OG5	OG4	OG3	OG2	OG1
LVDS Channel O2	LVDS output	D26	D25	D24	D22	D21	D20	D19
	Data order	DE	NA	NA	OB5	OB4	OB3	OB2
LVDS Channel O3	LVDS output	D23	D17	D16	D11	D10	D5	D27
	Data order	NA	OB7	OB6	OG7	OG6	OR7	OR6
LVDS Channel E0	LVDS output	D7	D6	D4	D3	D2	D1	D0
	Data order	EG0	ER5	ER4	ER3	ER2	ER1	ER0
LVDS Channel E1	LVDS output	D18	D15	D14	D13	D12	D9	D8
	Data order	EB1	EB0	EG5	EG4	EG3	EG2	EG1
LVDS Channel E2	LVDS output	D26	D25	D24	D22	D21	D20	D19
	Data order	DE	NA	NA	EB5	EB4	EB3	EB2
LVDS Channel E3	LVDS output	D23	D17	D16	D11	D10	D5	D27
	Data order	NA	EB7	EB6	EG7	EG6	ER7	ER6

### 4.3.2 COLOR DATA INPUT ASSIGNMENT

The brightness of each primary color (red, green and blue) is based on the 8-bit gray scale data input for the color. The higher the binary the color. The table below provides the assignment of color versus data input.

Color		Data Signal																							
		Red								Green								Blue							
		R7	R6	R5	R4	R3	R2	R1	R0	G7	G6	G5	G4	G3	G2	G1	G0	B7	B6	B5	B4	B3	B2	B1	B0
Basic Colors	Black	0	0	0	0	0	0	0	0	0	0	0	0	0	0	0	0	0	0	0	0	0	0	0	0
	Red	1	1	1	1	1	1	1	1	0	0	0	0	0	0	0	0	0	0	0	0	0	0	0	0
	Green	0	0	0	0	0	0	0	0	1	1	1	1	1	1	1	1	0	0	0	0	0	0	0	0
	Blue	0	0	0	0	0	0	0	0	0	0	0	0	0	0	0	0	1	1	1	1	1	1	1	1
	Cyan	0	0	0	0	0	0	0	0	1	1	1	1	1	1	1	1	1	1	1	1	1	1	1	1
	Magenta	1	1	1	1	1	1	1	1	0	0	0	0	0	0	0	0	1	1	1	1	1	1	1	1
	Yellow	1	1	1	1	1	1	1	1	1	1	1	1	1	1	1	1	0	0	0	0	0	0	0	0
	White	1	1	1	1	1	1	1	1	1	1	1	1	1	1	1	1	1	1	1	1	1	1	1	1
Gray Scale Of Red	Red(0) / Dark	0	0	0	0	0	0	0	0	0	0	0	0	0	0	0	0	0	0	0	0	0	0	0	0
	Red(1)	0	0	0	0	0	0	0	1	0	0	0	0	0	0	0	0	0	0	0	0	0	0	0	0
	Red(2)	0	0	0	0	0	0	1	0	0	0	0	0	0	0	0	0	0	0	0	0	0	0	0	0
	:	:	:	:	:	:	:	:	:	:	:	:	:	:	:	:	:	:	:	:	:	:	:	:	:
	:	:	:	:	:	:	:	:	:	:	:	:	:	:	:	:	:	:	:	:	:	:	:	:	:
	Red(253)	1	1	1	1	1	1	1	0	1	0	0	0	0	0	0	0	0	0	0	0	0	0	0	0
	Red(254)	1	1	1	1	1	1	1	1	0	0	0	0	0	0	0	0	0	0	0	0	0	0	0	0
Red(255)	1	1	1	1	1	1	1	1	0	0	0	0	0	0	0	0	0	0	0	0	0	0	0	0	
Gray Scale Of Green	Green(0)/Dark	0	0	0	0	0	0	0	0	0	0	0	0	0	0	0	0	0	0	0	0	0	0	0	0
	Green(1)	0	0	0	0	0	0	0	0	0	0	0	0	0	0	1	0	0	0	0	0	0	0	0	0
	Green(2)	0	0	0	0	0	0	0	0	0	0	0	0	0	0	1	0	0	0	0	0	0	0	0	0
	:	:	:	:	:	:	:	:	:	:	:	:	:	:	:	:	:	:	:	:	:	:	:	:	:
	:	:	:	:	:	:	:	:	:	:	:	:	:	:	:	:	:	:	:	:	:	:	:	:	:
	Green(253)	0	0	0	0	0	0	0	1	1	1	1	1	1	1	0	1	0	0	0	0	0	0	0	0
	Green(254)	0	0	0	0	0	0	0	1	1	1	1	1	1	1	1	0	0	0	0	0	0	0	0	0
Green(255)	0	0	0	0	0	0	0	1	1	1	1	1	1	1	1	1	0	0	0	0	0	0	0	0	
Gray Scale Of Blue	Blue(0) / Dark	0	0	0	0	0	0	0	0	0	0	0	0	0	0	0	0	0	0	0	0	0	0	0	0
	Blue(1)	0	0	0	0	0	0	0	0	0	0	0	0	0	0	0	0	0	0	0	0	0	0	0	1
	Blue(2)	0	0	0	0	0	0	0	0	0	0	0	0	0	0	0	0	0	0	0	0	0	0	1	0
	:	:	:	:	:	:	:	:	:	:	:	:	:	:	:	:	:	:	:	:	:	:	:	:	:
	:	:	:	:	:	:	:	:	:	:	:	:	:	:	:	:	:	:	:	:	:	:	:	:	:
	Blue(253)	0	0	0	0	0	0	0	0	0	0	0	0	0	0	0	1	1	1	1	1	1	1	0	1
	Blue(254)	0	0	0	0	0	0	0	0	0	0	0	0	0	0	0	1	1	1	1	1	1	1	1	0
Blue(255)	0	0	0	0	0	0	0	0	0	0	0	0	0	0	0	1	1	1	1	1	1	1	1	1	

Note (1) 0: Low Level Voltage, 1: High Level Voltage

## 5.0 Optical Specifications

The optical characteristics are measured under stable conditions as following notes

Item	Symbol	Condition	Min.	Typ.	Max.	Unit	Note	
Color Chromaticity (CIE 1931)	Red	Rx	$\theta_x=0^\circ, \theta_y=0^\circ$ CS-2000 R=G=B=255 Gray scale	Typ - 0.05	0.652	Typ + 0.05	-	(1), (5)
		Ry			0.338			
	Green	Gx			0.333			
		Gy			0.613			
	Blue	Bx			0.150			
		By			0.050			
	White	Wx			0.313			
		Wy			0.329			
Center Luminance of White	$L_c$		800	1000	-	cd/m <sup>2</sup>	(4), (5)	
Contrast Ratio	CR		600	800	-	-	(2), (5)	
Response Time	$T_R$	$\theta_x=0^\circ, \theta_y=0^\circ$	-	13	18	ms	(3)	
	$T_F$		-	12	17			
White Variation	W	$\theta_x=0^\circ, \theta_y=0^\circ$	70	-	-	%	(5), (6)	
Viewing Angle	Horizontal	$\theta_{x+}$	$CR \geq 10$	80	85	---	Deg.	(1), (5)
		$\theta_{x-}$		80	85	---		
	Vertical	$\theta_{y+}$		80	85	---		
		$\theta_{y-}$		80	85	---		

Note (1) Definition of Viewing Angle ( $\theta_x, \theta_y$ ):

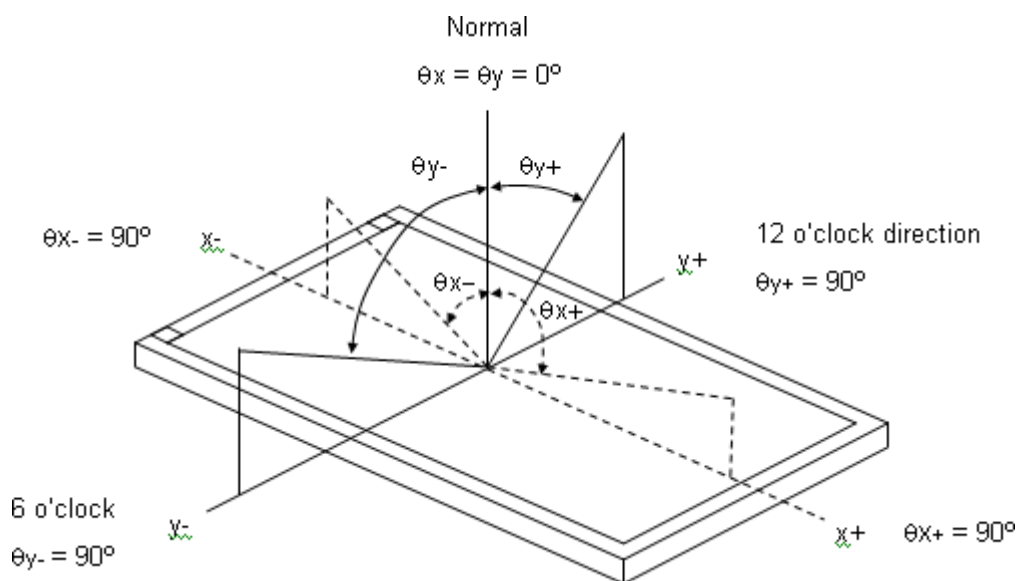

Note (2) Definition of Contrast Ratio (CR):

The contrast ratio can be calculated by the following expression. Contrast Ratio (CR) =  $L_{255} / L_0$   
 $L_{255}$ : Luminance of gray level 255  $L_0$ : Luminance of gray level 0

CR = CR (5)

CR (X) is corresponding to the Contrast Ratio of the point X at Figure in Note (6).

Note (3) Definition of Response Time ( $T_R$ ,  $T_F$ ):

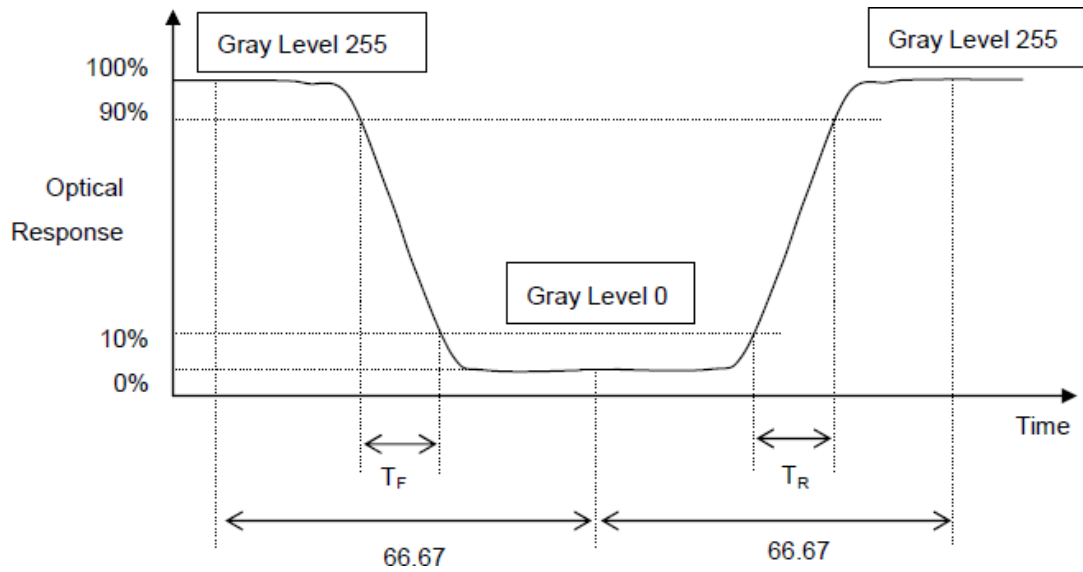

Note (4) Definition of Luminance of White ( $L_C$ ):

Measure the luminance of gray level 255 at center point  $L_C = L(5)$

$L(x)$  is corresponding to the luminance of the point X at Figure in Note (6).

Note (5) Measurement Setup:

The LCD module should be stabilized at given temperature for 30 minutes to avoid abrupt temperature change during measuring. In order to stabilize the luminance, the measurement should be executed after lighting Backlight for 30 minutes in a windless room.

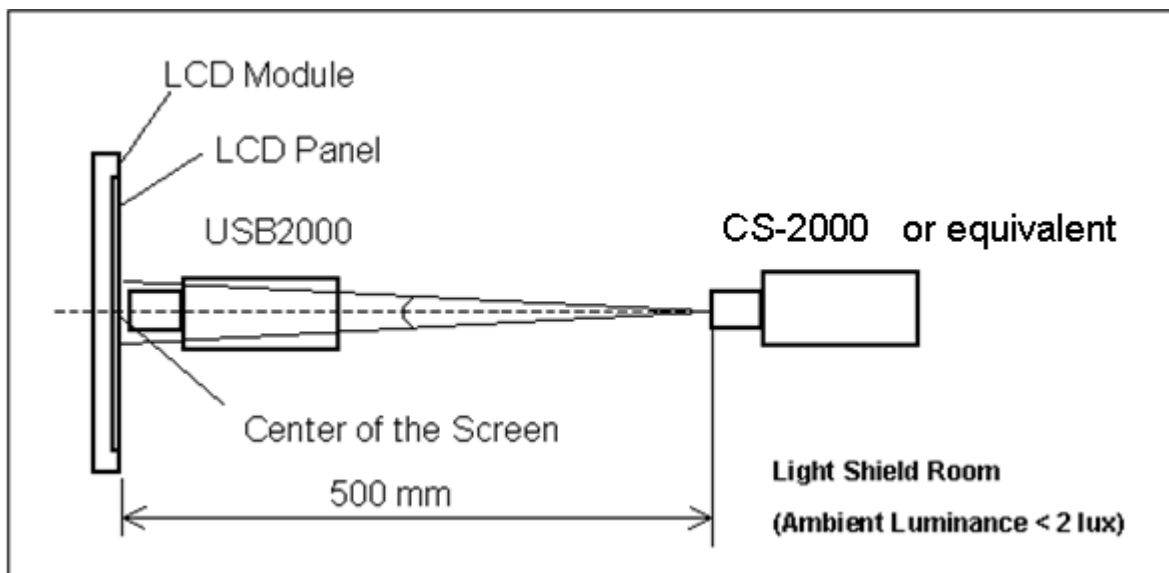

Note (6) Definition of White Variation

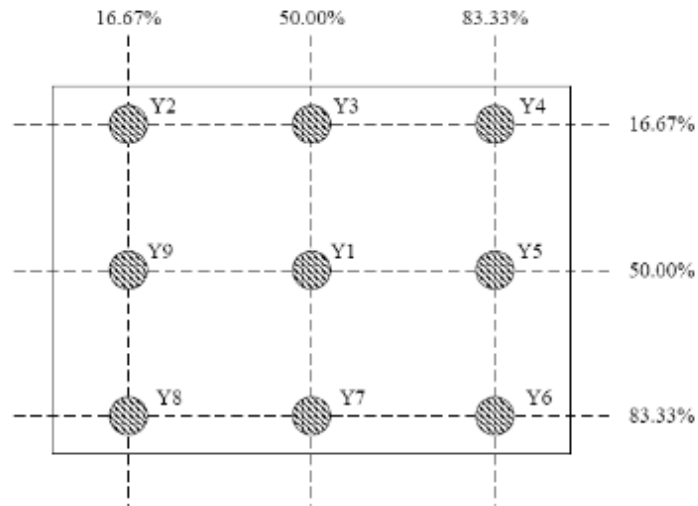

$$\text{Luminance uniformity} = \frac{\text{(Min Luminance of 9 points)}}{\text{(Max Luminance of 9 points)}} \times 100\%$$



## 6. Interface Connections

Pin #	Signal Name	Description
1	GND	Ground
2	NC	Not Connect
3	VDD	Power Supply
4	VDD	Power Supply
5	GND	Ground
6	GND	Ground
7	NC	Not Connect
8	NC	Not Connect
9	GND	Ground
10	IN0-	-LVDS differential data input
11	IN0+	+LVDS differential data input
12	IN1-	-LVDS differential data input
13	IN1+	+LVDS differential data input
14	IN2-	-LVDS differential data input
15	IN2+	+LVDS differential data input
16	CLK-	-LVDS differential clock
17	CLK+	+LVDS differential clock
18	IN3-	-LVDS differential data input
19	IN3+	+LVDS differential data input
20	E_IN0-	-LVDS differential data input
21	E_IN0+	+LVDS differential data input
22	E_IN1-	-LVDS differential data input
23	E_IN1+	+LVDS differential data input
24	E_IN2-	-LVDS differential data input
25	E_IN2+	+LVDS differential data input
26	E_CLK-	-LVDS differential clock
27	E_CLK+	+LVDS differential clock
28	E_IN3-	-LVDS differential data input
29	E_IN3+	+LVDS differential data input
30	GND	Ground
31	GND	Ground
32	VLED	LED Power Supply
33	VLED	LED Power Supply

34	VLED	LED Power Supply
35	VLED	LED Power Supply
36	LED_EN	LED Enable Pin : High→Enable
37	LED_PWM	PWM Signal for LED Dimming Control
38	GND	Ground
39	GND	Ground
40	GND	Ground

## 7. LED Driving Conditions

Item	Symbol	Values			Unit	Note
		Min.	Typ.	Max.		
LED Driver voltage	VLED	-	12	-	V	
Power Supply Current For LED Driver	ILED	-	1600	-	mA	VLED=12V VADJ=5V (duty 100%)
ADJ Input Voltage	V <sub>ADJ</sub>	-	5	VLED	V	duty=100%
ADJ Dimming Freq.	F <sub>ADJ</sub>	0.1		30	kHz	
LED voltage	V <sub>AK</sub>	--	35.2		V	I <sub>AK</sub> =440mA Ta=25°C
LED current	I <sub>AK</sub>	--	440	--	mA	Ta=25°C
		--	330	--	mA	Ta=60°C
LED Life Time	-	--	50K	--	Hour	Note (2)

Note (1) The constant current source is needed for white LED back-light driving.

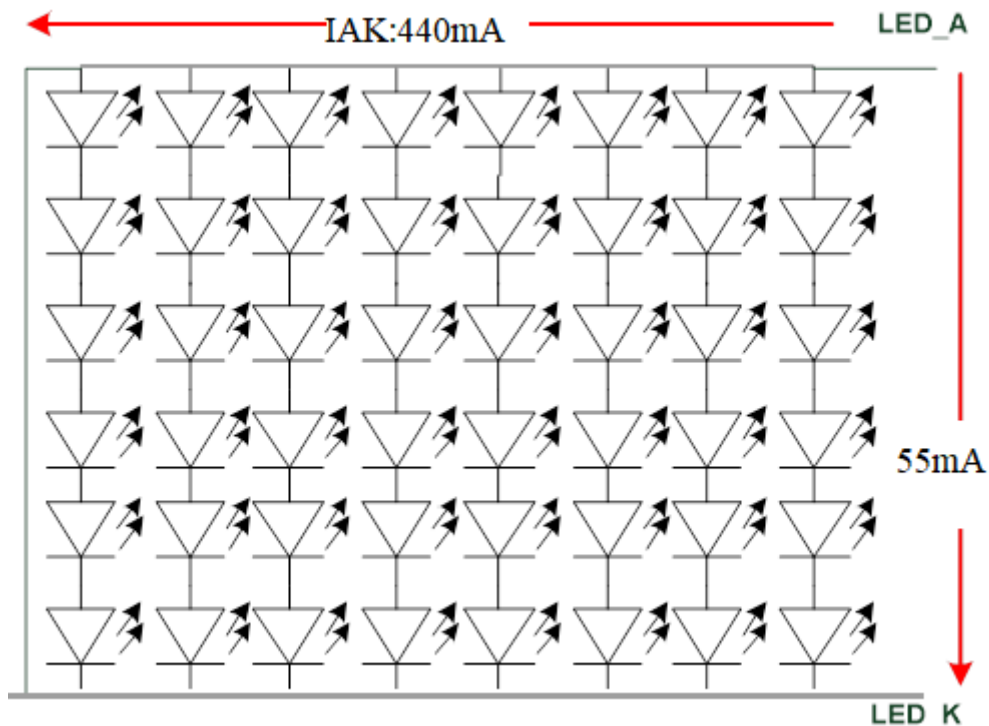

Note (2) : Condition:  $T_a=25^{\circ}\text{C}$ , continuous lighting

Life time is estimated data. Definitions of failure:

1. LCM brightness becomes half of the minimum value.
2. LED doesn't light normally.

When LCM is operated over  $40^{\circ}\text{C}$  ambient temperature, the ILED should follow :

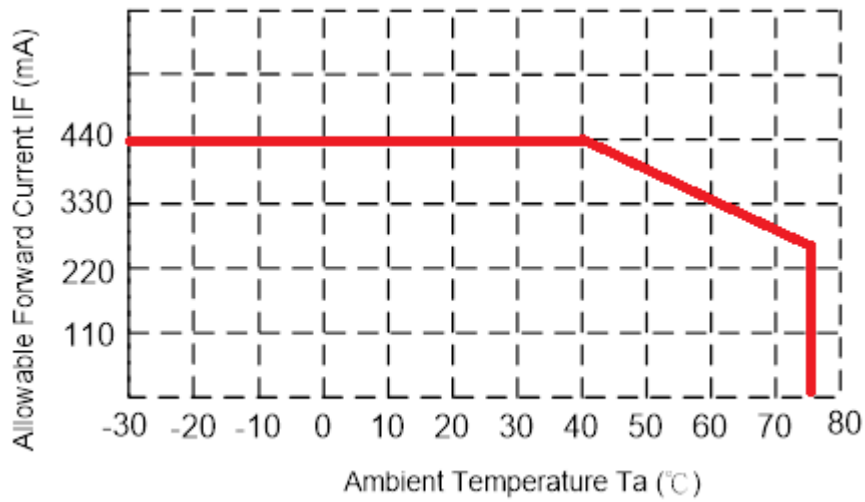

## 8. Reliability Test

The reliability test items and its conditions are shown below.

Test Item	Test Conditions	Note
High Temperature Operation	75±3°C , t=240 hrs	
Low Temperature Operation	-30±3°C , t=240 hrs	
High Temperature Storage	80±3°C , t=240 hrs	1,2
Low Temperature Storage	-30±3°C , t=240 hrs	1,2
Storage at High Temperature and Humidity	50°C, 80% RH , 240 hrs	1,2
Thermal Shock Test	-20°C (30min) ~ 60°C (30min) , 100 cycles	1,2
Vibration Test (Packing)	Sweep frequency : 10~55~10 Hz/1min Amplitude : 0.75mm Test direction : X.Y.Z/3 axes Duration : 30 min/each axis	2

Note (1) Condensation of water is not permitted on the module.

Note (2) The module should be inspected after 1 hour storage in normal conditions (15-35°C, 45-65%RH).

Note (3) The module shouldn't be tested more than one condition, and all the test conditions are independent.

Note (4) All the reliability tests should be done without protective film on the module.

## **9 . GENERAL PRECAUTION**

### **9.1 Use Restriction**

This product is not authorized for use in life supporting systems, aircraft navigation control systems, military systems and any other application where performance failure could be life-threatening or otherwise catastrophic.

### **9.2 Disassembling or Modification**

Do not disassemble or modify the module. It may damage sensitive parts inside LCD module, and may cause scratches or dust on the display. AMPIRE does not warrant the module, if customers disassemble or modify the module.

### **9.3 Breakage of LCD Panel**

- (1) If LCD panel is broken and liquid crystal spills out, do not ingest or inhale liquid crystal, and do not contact liquid crystal with skin.
- (2) If liquid crystal contacts mouth or eyes, rinse out with water immediately.
- (3) If liquid crystal contacts skin or cloths, wash it off immediately with alcohol and rinse thoroughly with water.
- (4) Handle carefully with chips of glass that may cause injury, when the glass is broken.

### **9.4 Electric Shock**

- (1) Disconnect power supply before handling LCD module.
- (2) Do not pull or fold the LED cable.
- (3) Do not touch the parts inside LCD modules and the fluorescent LED's connector or cables in order to prevent electric shock.

### **9.5 Absolute Maximum Ratings and Power Protection Circuit**

- (1) Do not exceed the absolute maximum rating values, such as the supply voltage variation, input voltage variation, variation in parts' parameters, environmental temperature, etc., otherwise LCD module may be damaged.
- (2) Please do not leave LCD module in the environment of high humidity and high temperature for a long time.
- (3) It's recommended to employ protection circuit for power supply.

## **9.6 Operation**

- (1) Do not touch, push or rub the polarizer with anything harder than HB pencil lead.
- (2) Use fingerstalls of soft gloves in order to keep clean display quality, when persons handle the LCD module for incoming inspection or assembly.
- (3) When the surface is dusty, please wipe gently with absorbent cotton or other soft material.
- (4) Wipe off saliva or water drops as soon as possible. If saliva or water drops contact with polarizer for a long time, they may cause deformation or color fading.
- (5) When cleaning the adhesives, please use absorbent cotton wetted with a little petroleum benzene or other adequate solvent.

## **9.7 Mechanism**

Please mount LCD module by using mounting holes arranged in four corners tightly.

## **9.8 Static Electricity**

- (1) Protection film must remove very slowly from the surface of LCD module to prevent from electrostatic occurrence.
- (2) Because LCD modules use CMOS-IC on circuit board and TFT-LCD panel, it is very weak to electrostatic discharge. Please be careful with electrostatic discharge. Persons who handle the module should be grounded through adequate methods.

## **9.9 Strong Light Exposure**

The module shall not be exposed under strong light such as direct sunlight. Otherwise, display characteristics may be changed.

## **9.10 Disposal**

When disposing LCD module, obey the local environmental regulations.

## **9.11 Others**

Do not keep the LCD at the same display pattern continually. The residual image will happen and it will damage the LCD. Please use screen saver.

# 10.0 Outline Dimension

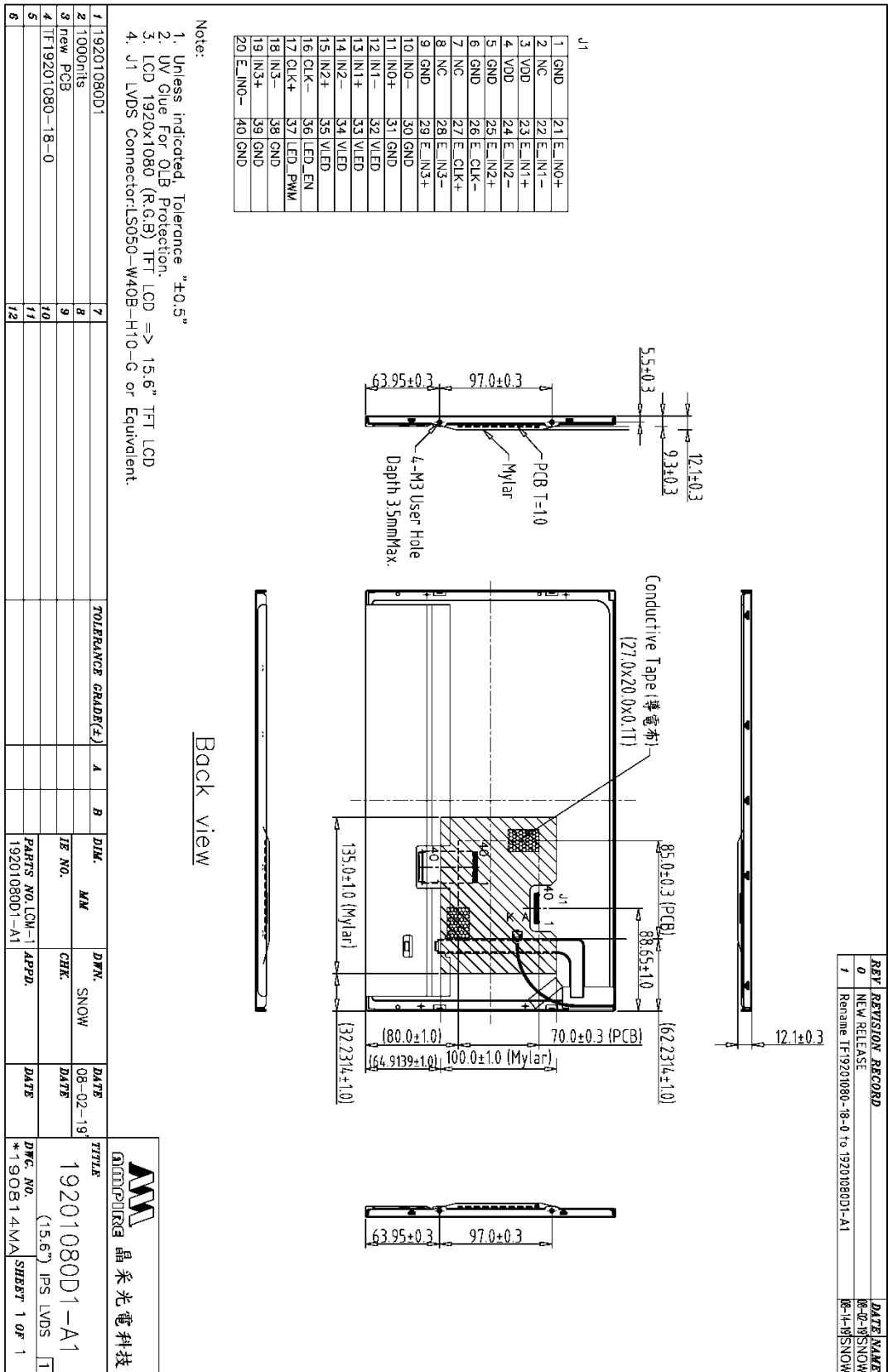



REV	REVISION RECORD	DATE	NAME
0	NEW RELEASE	08-02-19	SNOW
1	Rename TF19201080-18-0 to 19201080D1-A1	08-14-19	SNOW

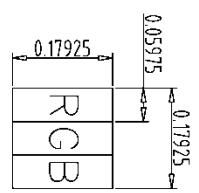

A Block

J1

1	GND	21	E_IN0+
2	NC	22	E_IN1-
3	VDD	23	E_IN1+
4	VDD	24	E_IN2-
5	GND	25	E_IN2+
6	GND	26	E_CLK-
7	NC	27	E_CLK+
8	NC	28	E_IN3-
9	GND	29	E_IN3+
10	INO-	30	GND
11	INO+	31	GND
12	IN1-	32	VLED
13	IN1+	33	VLED
14	IN2-	34	VLED
15	IN2+	35	VLED
16	CLK-	36	LED_EN
17	CLK+	37	LED_PWM
18	IN3-	38	GND
19	IN3+	39	GND
20	E_IN0-	40	GND

Note:  
 1. Unless indicated, Tolerance "±0.5"  
 2. UV Glue For OLB Protection.  
 3. LCD 1920x1080 (RGB) TFT LCD => 15.6" TFT LCD  
 4. J1 LVDS Connector:LS050-W40B-H10-C or Equivalent.

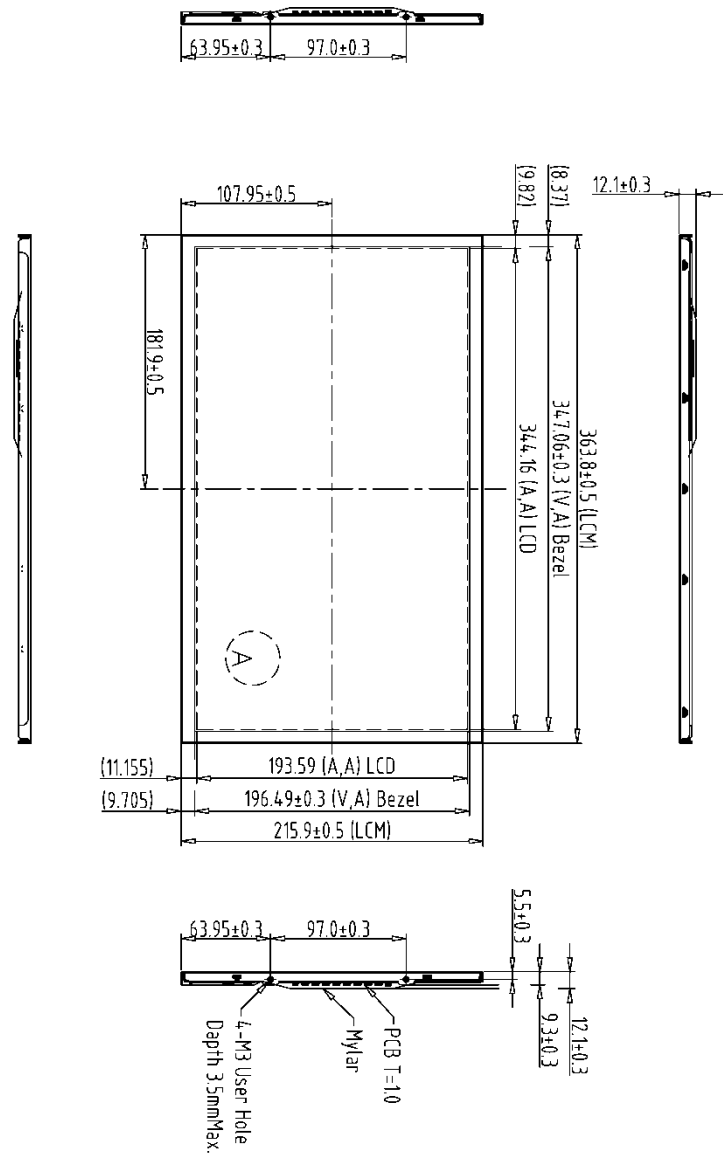

REV	DESCRIPTION	DATE	NAME
1	19201080D1	08-02-19	SNOW
2	1000onts		
3	new PCB		
4	TF19201080-18-0		
5			
6			

TOLERANCE	GRADE(F)	A	B	DIM.	MM	DRAWN	DATE
				IE NO.		SNOW	08-02-19
				PARTS NO. LCM			DATE
				19201080D1-A1			

TITLE	DWG. NO.	SHEET
19201080D1-A1	(15.6") IPS LVDS	1 OF 1
AMPIRE 晶采光電科技	*190813MA	

Our company network supports you worldwide with offices in Germany, Austria, Switzerland, the UK and the USA. For more information please contact:

## Headquarters

### Germany



#### FORTEC Elektronik AG

Augsburger Str. 2b  
82110 Germering

Phone: +49 89 894363-0  
E-Mail: [sales@fortecag.de](mailto:sales@fortecag.de)  
Internet: [www.fortecag.de](http://www.fortecag.de)

## Fortec Group Members

### Austria



#### FORTEC Elektronik AG

##### Office Vienna

Nuschinggasse 12  
1230 Wien

Phone: +43 1 8673492-0  
E-Mail: [office@fortec.at](mailto:office@fortec.at)  
Internet: [www.fortec.at](http://www.fortec.at)

### Germany



#### Distec GmbH

Augsburger Str. 2b  
82110 Germering

Phone: +49 89 894363-0  
E-Mail: [info@distec.de](mailto:info@distec.de)  
Internet: [www.distec.de](http://www.distec.de)



#### FORTEC Elektronik AG

Lechwiesenstraße 9  
86899 Landsberg am Lech

Phone: +49 8191 91172-0  
E-Mail: [sales@fortecag.de](mailto:sales@fortecag.de)  
Internet: [www.fortecag.de](http://www.fortecag.de)

### Switzerland



#### ALTRAC AG

Bahnhofstraße 3  
5436 Würenlos

Phone: +41 44 7446111  
E-Mail: [info@altrac.ch](mailto:info@altrac.ch)  
Internet: [www.altrac.ch](http://www.altrac.ch)

### United Kingdom



#### Display Technology Ltd.

Osprey House, 1 Osprey Court  
Hichingbrooke Business Park  
Huntingdon, Cambridgeshire, PE29 6FN

Phone: +44 1480 411600  
E-Mail: [info@displaytechnology.co.uk](mailto:info@displaytechnology.co.uk)  
Internet: [www.displaytechnology.co.uk](http://www.displaytechnology.co.uk)

### USA



#### Apollo Display Technologies, Corp.

87 Raynor Avenue,  
Unit 1 Ronkonkoma,  
NY 11779

Phone: +1 631 5804360  
E-Mail: [info@apolloDisplays.com](mailto:info@apolloDisplays.com)  
Internet: [www.apolloDisplays.com](http://www.apolloDisplays.com)